

# Showglass **Zeta** Kiosk

## Datasheet

Welcome to oemKIOSKS



---

Touch...The Sky

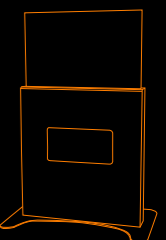

# Showglass Zeta

Interactivity platform with large dimensions

The Showglass model was developed for indoor use to work as a revolutionary dynamic advertising and multimedia system.

This model can be manufactured in stainless steel or painted steel (available in all RAL colors).

This kiosk was designed specifically to work as an innovative advertising system, which receives the image that is projected through a video projector. The Showglass also has an acrylic structure, with light in the front, for advertising (logo).

The dimensions of the image can vary, depending on quality and distance from which the projector is placed. However the Showglass is much more than a simple projection system of images, videos, websites, etc..

By placing an interactive foil on the glass where the image is projected, it is possible to transform the Showglass kiosk into an interactive Kiosk with large dimensions, impossible to achieve with LCD's and touchscreen monitors

With all these features the Showglass is specially suited for all types of applications where impact, size & interactivity are necessary.

The Showglass must be equipped with a computer and a video projector.

## Technical Specifications Showglass Zeta Kiosk

Dimensions: H1800 x W1350 x D450

Weight: aprox. 60 Kg.

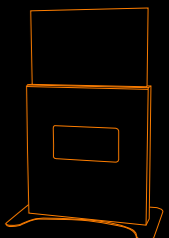

# Showglass Zeta

Distance comparison and main features

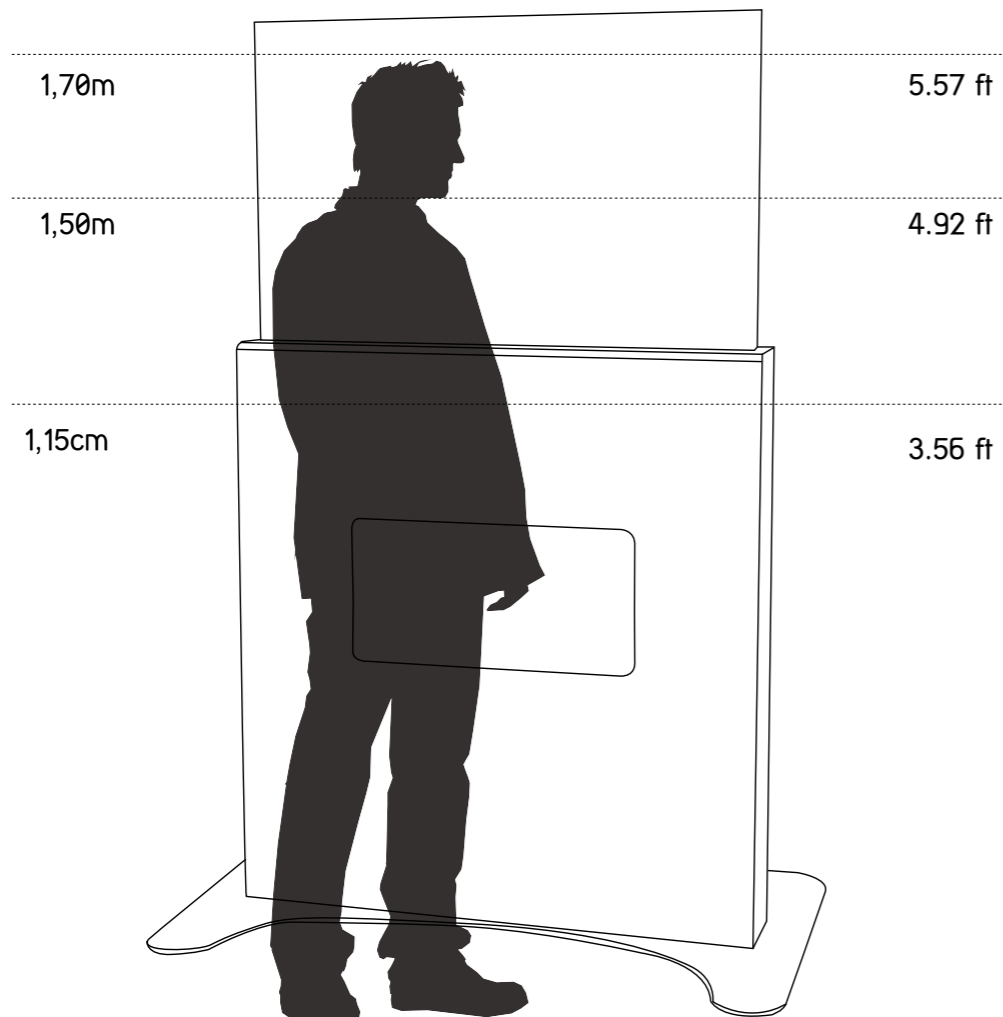

## Type

Indoor

## Materials

Painted Steel

Stainless Steel

MDF

## Options

Display / Glass up to 108"

YdSignage Software

Directional Sound

Webcam

Proximity Sensor

Audience measurement

Interactivity / Touchscreen

(Other options available upon request)

Showglass Zeta  
Distance comparison and main features

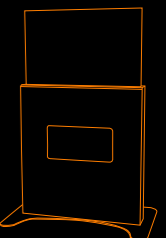

# Showglass Zeta

Kiosk measures

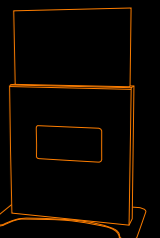
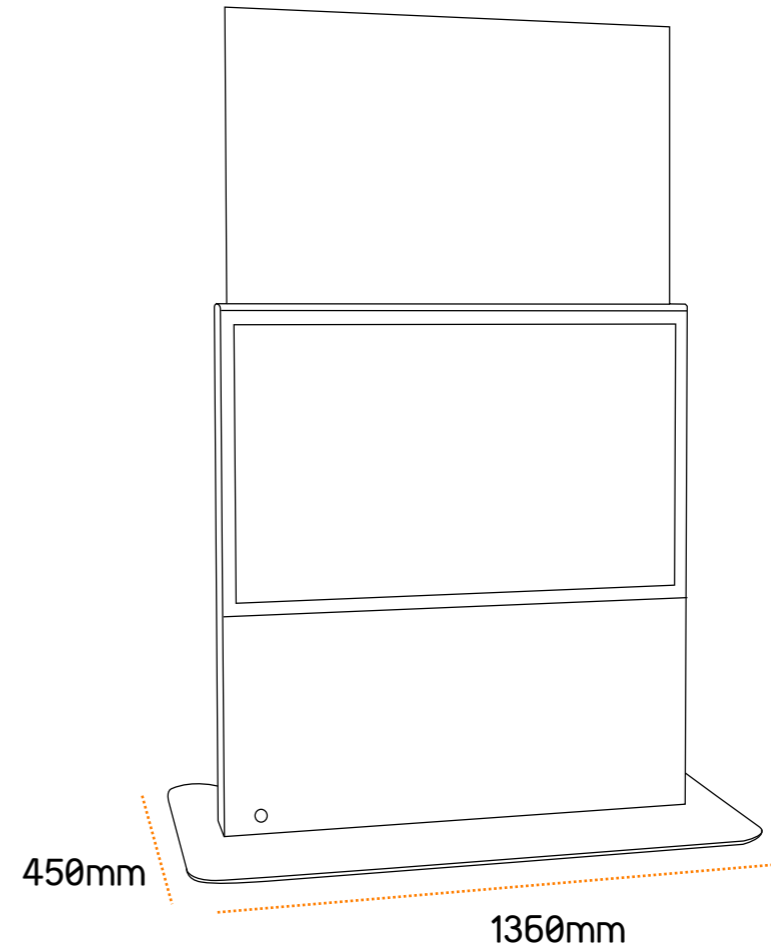
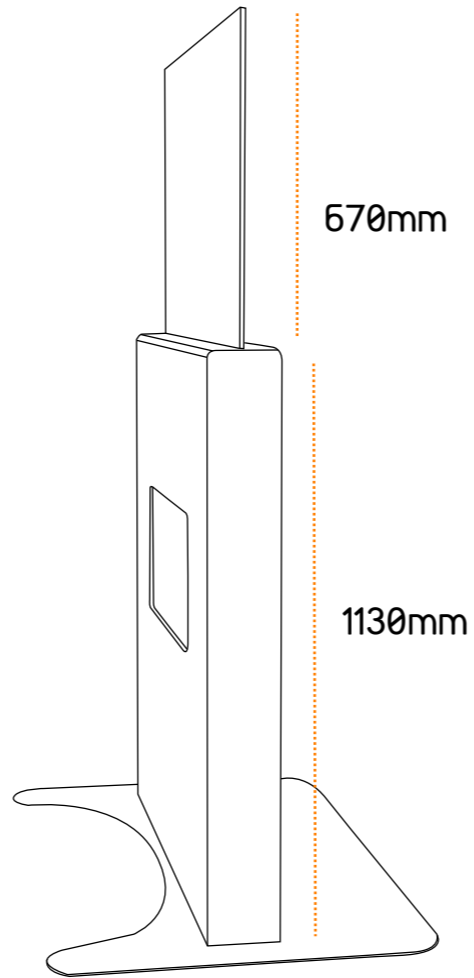
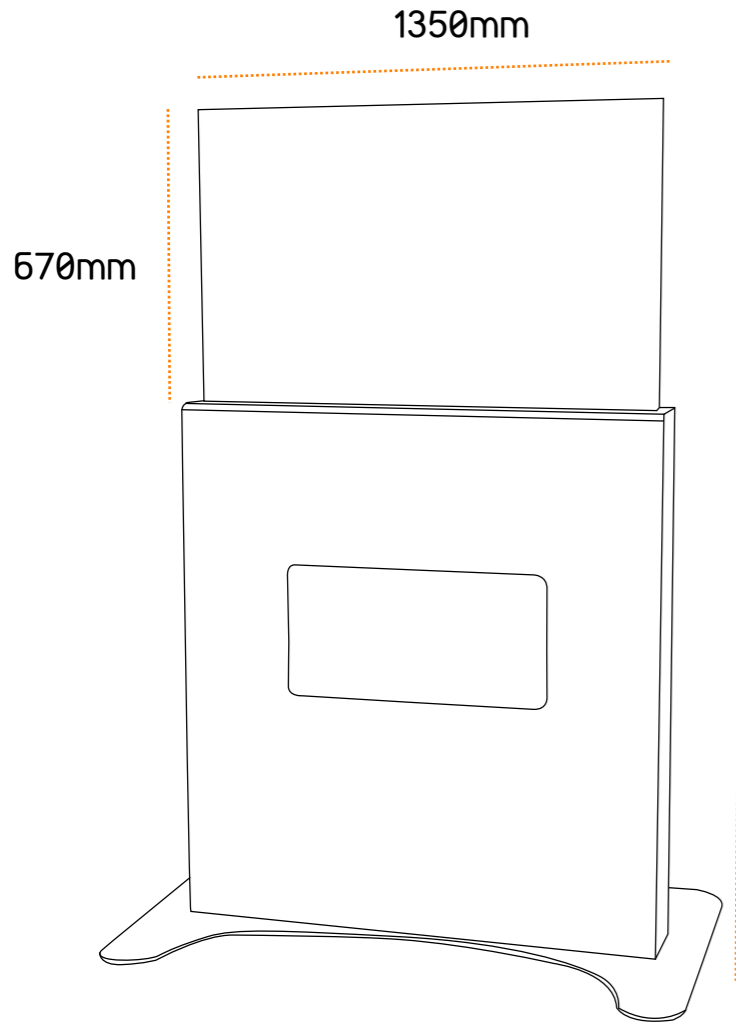

# Showglass Zeta

Technical data

---

## Dimensions:

- Display / Glass up to 108" (resolution: 1280 x 1024 Pixel)
- H1800 W1350 D450

## Weight:

60 kg

## Configuration:

- Interactivity platform with large dimensions
- Stainless steel AISI304 or painted steel (RAL Colors)
- Steel plate of 1,5mm to 2,5mm
- Integrated speakers

## Optional:

- Displays up to 108"
- Atom or Dual Core PC computer
- Microsoft Windows 7 Professional
- Ykiosk software package
- Interactivity / Touchscreen
- Wireless networking - WLAN
- Bluetooth functionality
- Webcam

• Other components can be integrated changing kiosk dimensions: ticket printer, coin validator, bill validator, card readers, antivandalic keyboard, proximity sensor, etc.

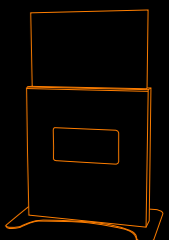

# oemKIOSKS | Your white label kiosk company

This document is provided only for information purposes. The presented information is subject to change without prior notice, given the constant evolution of content.  
THE PARTTEAM GROUP is not responsible for any errors or omissions in this document, based on the information it contains, as a result of its publication.



oemKIOSKS | Partteam Group Portugal | Rua Nova da Nespereira, Pavilhão 10 | 4770 -287 Lagoa - Vila Nova de Famalicão  
tel: +351 252 378 589 | +351 252 327 185 | fax: + 351 252 378 591 | Portugal  
[www.oemkiosks.com](http://www.oemkiosks.com) | [oem@oemkiosks.com](mailto:oem@oemkiosks.com)